

# E4991B Impedance Analyzer

1 MHz to 500 MHz/1 GHz/3 GHz

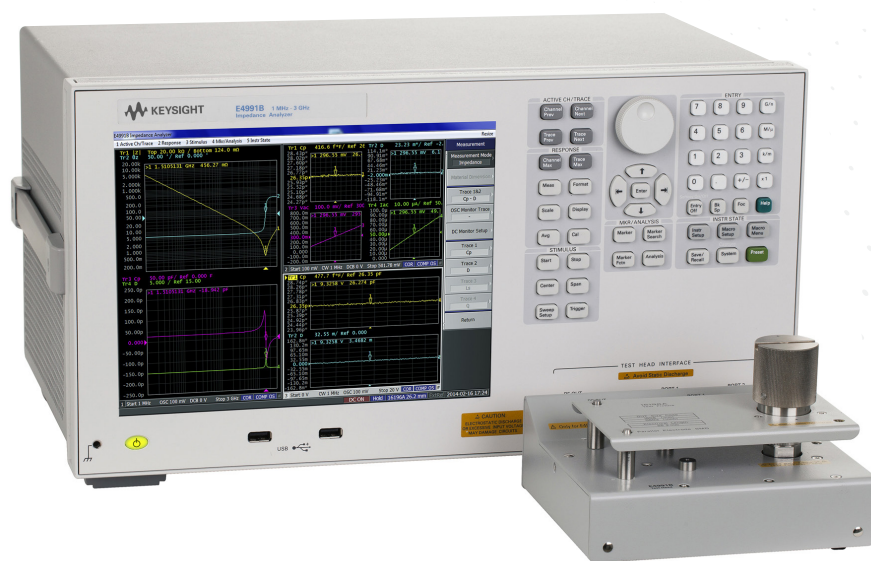

**4TECT**

ООО «4TECT»

Телефон: +7 (499) 685-4444

info@4test.ru

www.4test.ru

 **KEYSIGHT**  
TECHNOLOGIES

# Keysight Impedance Analyzer Series

## Achieve success with the industry standard for impedance measurements

Keysight Technologies, Inc. and its predecessors have contributed to innovations and product excellence in impedance analysis for over half a century. Whether your application is in R&D, production, quality assurance, or incoming inspection, we take pride in contributing to your success. We strive to deliver complete solutions to meet your needs, from impedance analyzers to a wide variety of test accessories. Achieve success with Keysight's impedance measurement solutions.





## Real characteristics – achieved only with an impedance analyzer

Only Keysight impedance analyzers provide unparalleled accuracy for component evaluation mOhm to Mohm, from 5 Hz to 3 GHz. Add an impedance analyzer to your lab and achieve real characteristics of high quality components.



## Select the appropriate frequency range for your application

Keysight's impedance analyzers provide the best performance in the industry with frequency options to meet your needs at an affordable price. You can select the most appropriate frequency range for your application, from 10 MHz to 3 GHz. Flexible frequency upgrade options are also available. You can choose just what you require today with the least amount of investment and upgrade later as needs arise. Select what's best for you – and achieve both your engineering and business goals.

### E4990A Impedance analyzer

- Impedance analyzer	Option 120		20 Hz to 120 MHz
- Auto balancing bridge	Option 050		20 Hz to 50 MHz
- Basic accuracy 0.08% (typ. 0.045%)	Option 030		20 Hz to 30 MHz
- Z-range: 25 mΩ – 40 MΩ (10% accuracy)	Option 020		20 Hz to 20 MHz
	Option 010		20 Hz to 10 MHz

### E4991B Impedance analyzer

- Impedance analyzer			
- RF-IV method	Option 300		1 MHz to 3 GHz
- Basic accuracy 0.65%	Option 100		1 MHz to 1 GHz
- Z-range: 120 mΩ – 52 kΩ (10% accuracy)	Option 050		1 MHz to 500 MHz
- Direct readout of material parameters			

### E5061B ENA Series network analyzer with Options 3L5 and 005

- LF-RF network analyzer (Option 3L5) with impedance analysis (Option 005)			
- Basic accuracy 2% (typical)			5 Hz to 3 GHz
- Z-range: 1 Ω – 2 kΩ (10% accuracy, typical S-parameter port)			
- Gain/Phase evaluation			

# Keysight E4991B Impedance Analyzer

The E4991B impedance analyzer has a frequency range of 1 MHz to 3 GHz and provides 0.65% basic accuracy over a wide impedance range, with a 40 V built-in DC bias source (Option 001).

Three frequency options (1 MHz to 500 MHz/1 GHz/3 GHz) and frequency upgrades allow you to choose the most appropriate option with the least amount of investment.

Material measurement options provide temperature characteristics analysis capabilities (Option 007) and direct read function of permittivity and permeability (Option 002).

A probe station connection kit (Option 010) offers an accurate on-wafer or micro-component impedance measurement solution up to 3 GHz.

Whether you are in R&D, QA, or inspection, the E4991B is an ideal solution for characterizing and evaluating electronic components, semiconductor devices, and materials.



## Application examples:

### Passive components

Impedance measurement of chip components such as capacitors, inductors, ferrite beads, resistors, or crystal/ceramic resonators.

Semiconductor components C-V characteristics analysis and equivalent series resistance measurement of varactor diodes.

### Dielectric material

Permittivity and loss tangent evaluation of plastics, ceramics, and printed circuit boards<sup>1</sup>.

### Magnetic material

Permeability and loss tangent evaluation of ferrite, amorphous and other magnetics materials<sup>1</sup>.

1. N1500A-005 materials measurement software is also available.

## Summary of Key Specifications

Operating frequency	1 MHz to 500 MHz/1 GHz/3 GHz (Option 050/100/300 respectively)
Measurement parameters	$ Z $ , $ Y $ , $\theta$ , R, X, G, B, L, C, D, Q, $ \Gamma $ , $\Gamma_x$ , $\Gamma_y$ , $\theta\Gamma$ , Vac, Iac, Vdc <sup>1</sup> , Idc <sup>1</sup>
Material measurement	$ \epsilon_r $ , $\epsilon_r'$ , $\epsilon_r''$ , $\tan\delta(\epsilon)$ , $ \mu_r $ , $\mu_r'$ , $\mu_r''$ , $\tan\delta(\mu)$ (E4991B Option 002 or N1500A Option 005 is required)
Basic impedance accuracy	$\pm 0.65\%$
Impedance range	120 m $\Omega$ to 52 k $\Omega$ (10% accuracy)
Measurement time	2.2 msec/point
OSC level	4.47 mVrms to 502 mVrms/89.4 $\mu$ Arms to 10 mArms/-40 dBm to +1 dBm
DC bias (Option 001)	0 to $\pm 40$ V/100 mA, 1 mV/2 $\mu$ A resolution
Sweep parameters	Frequency, OSC level (V/I), DC bias (V/I, Option 001 is required)
Sweep type	Linear, log, segment
Calibration	Open/short/50 $\Omega$ /low-loss-capacitor
Fixture compensation	Open/short, fixture electrical length, port extension
Number of measurement points	2 to 1601
Number of channels/traces	4-channel/4-trace
Marker	10 independent markers per trace
Data analysis	Equivalent circuit analysis, limit line test
Interface	USB (front 2, rear 4), LAN, USBTMC, GPIB, 24 bit I/O
Display	10.4 inch TFT color LCD with touch screen

1. Option 001 is required

# Truly User Friendly – Front Panel

The E4991B has a simple and intuitive user interface that allows you to make accurate repeatable measurements. View multiple parameters under various conditions at the same time on the large touch screen display. Frequently used functions are easily accessed through front panel hardkeys and softkeys that are organized for quick and easy navigation. Sophisticated analysis functions are available for better insight into your designs.

View 4-channels/4-traces on the 10.4 inch XGA color LCD with touch screen

User-friendly interface and help menu using the front-panel keys, or mouse and keyboard

Quick access to all necessary functions for basic measurements with Instr Setup key

Embedded context-sensitive help

Quick save and recall data and setup files on SSD

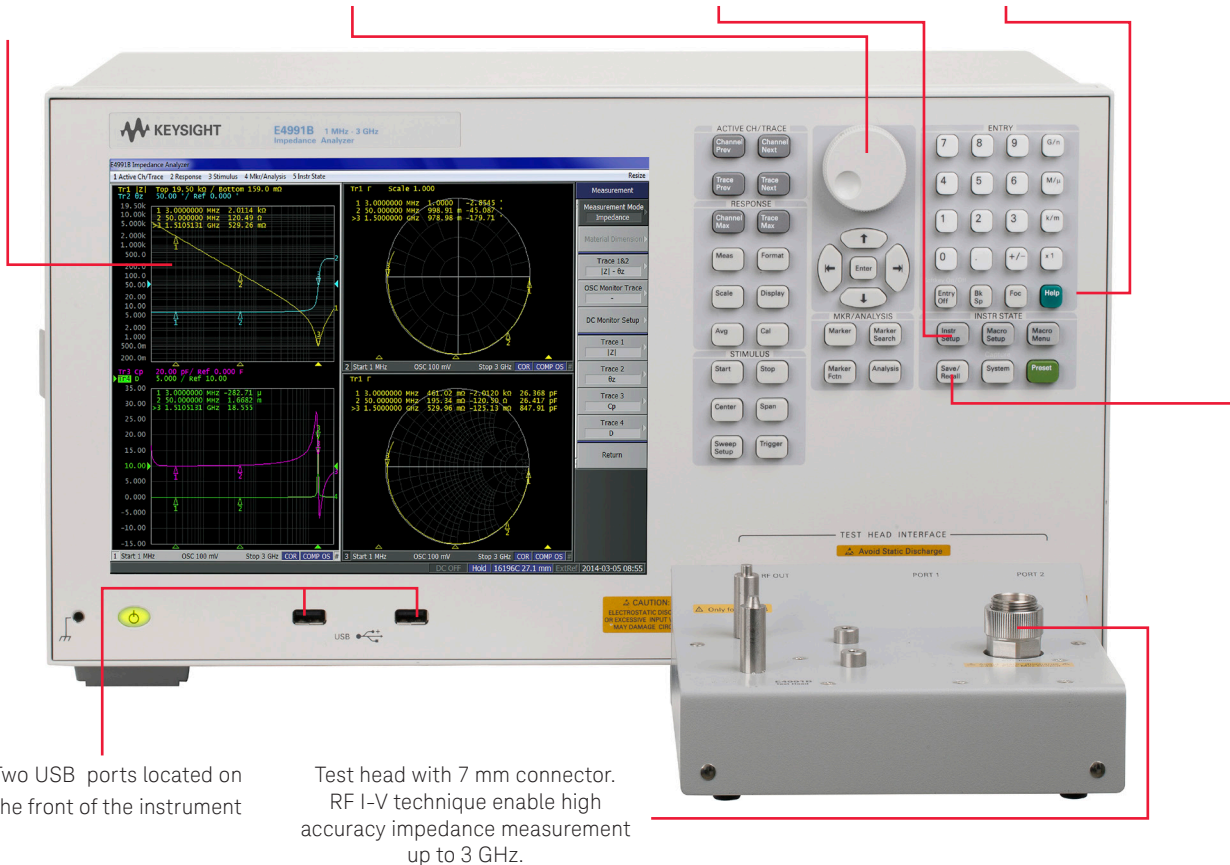

Two USB ports located on the front of the instrument

Test head with 7 mm connector. RF I-V technique enable high accuracy impedance measurement up to 3 GHz.

## Get answers quickly with the comprehensive context sensitive embedded help

- The Help menu includes everything you need – Quick Start Guide, Operation Manual, and Programming Manual
- Context-sensitive help allows you to quickly get information about selected softkeys
- When using command finder in the programming manual, you can quickly find SCPI commands with a one-key operation

Setting Sweep Range Using the Marker

1. Press **Marker Fctn**, then input the center value.
2. Click the softkey that corresponds to each value.

Softkey	Function
<b>Marker -&gt; Start</b>	Sets the lowest value to the stimulus value of the active marker on the currently active trace.
<b>Marker -&gt; Stop</b>	Sets the highest value to the stimulus value of the active marker on the currently active trace.
<b>Marker -&gt; Center</b>	Sets the center value to the stimulus value of the active marker on the currently active trace.

**NOTE:** If the reference marker is on and the stimulus value of the active marker is expressed by a value relative to the reference marker, the absolute stimulus value will be used to set the new sweep range.

## Truly User Friendly – Side and Rear Panel

Powerful yet compact, the E4991B will complement any existing testing environment and requires a minimal amount of space.

The high stability frequency reference (Option 1E5) allows you to improve the frequency accuracy and stability of the E4991B.

The E4991B provides flexible connectivity for remote control and easy test automation. Load measurement data from the E4991B to your PC via GPIB, LAN, or USB (type-B) interface. Digital I/O port (24 bit) is also available for data transfer with an external device, such as a handler.

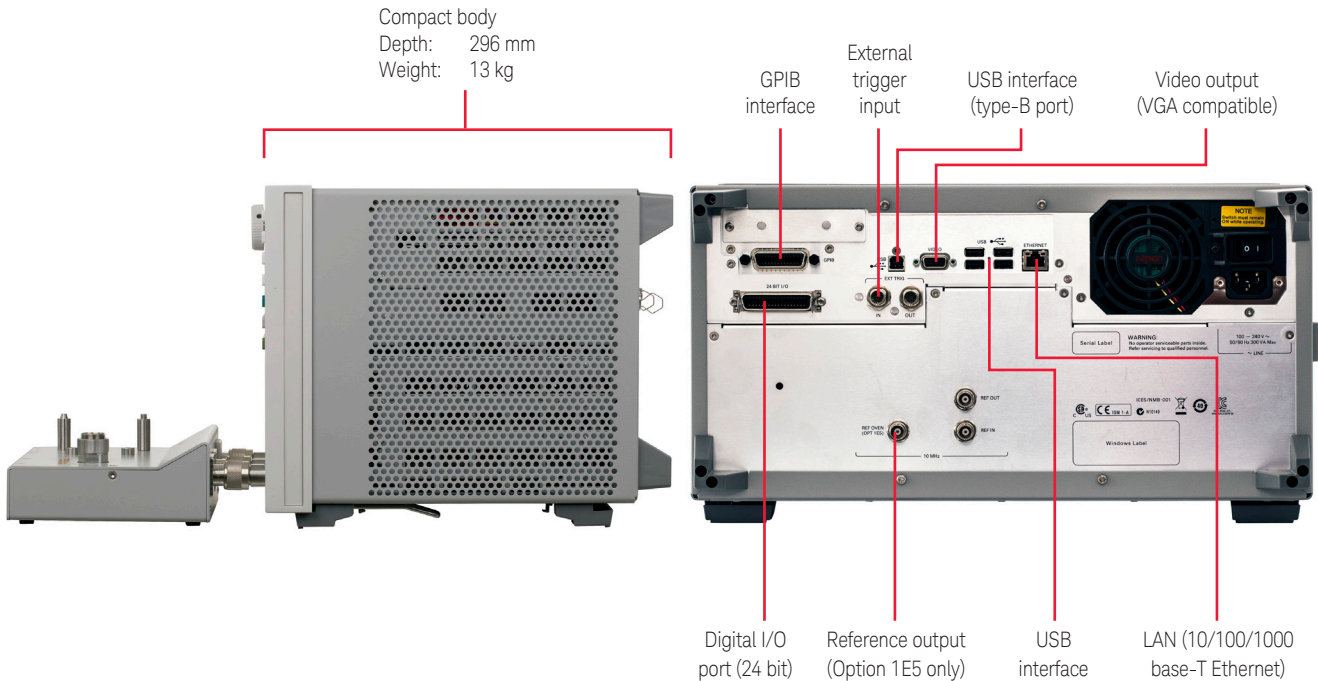

## Web server/control example

Conveniently control the E4991B with your PC and web browser via a LAN interface.

Remotely control the E4991B and acquire measurement data without any programming experience.

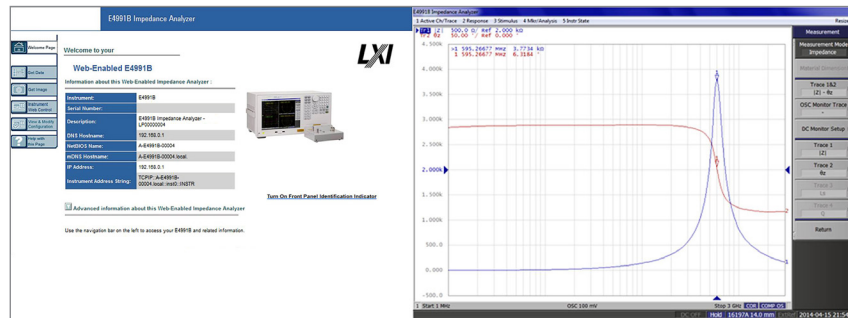

# Real-World Characterization Under Various Operating Conditions

## Comprehensive analysis using multi-channel/multi-trace

The 4-channel/4-trace capability helps you setup and measure multiple parameters under various operating conditions, such as frequency, test signal level, and DC level dependency. The measurement results can be enlarged on the display with one touch.

## Frequency dependency

Frequency dependency is common in all components because of the existence of parasitics. The E4991B can sweep test frequencies from 1 M to 3 GHz over a wide impedance range. It enables accurate evaluation of the frequency response including the self-resonant frequency point of components such as capacitors and inductors.

## Test signal level dependency

The test signal (AC) applied may affect the impedance characteristics of some devices. The E4991B can sweep test signal voltage from 4.47 mVrms to 502 mVrms, test signal current from 89.4  $\mu$ Arms to 10 mArms, or -40 dBm to +1 dBm to evaluate test signal level dependency.

The E4991B includes a feature that allows you to monitor both the voltage and current values of the test signal level actually applied to the DUT. The monitored voltage (Vac) and current (Iac) traces can be displayed.

## DC level dependency

DC level dependency is common in semiconductor components such as diodes and transistors. Some passive components are also DC level dependent. The E4991B with Option 001 DC bias can sweep DC voltage bias from -40 V to +40 V (1 mV resolution), or DC current bias from -100 mA to +100 mA (2  $\mu$ A resolution) to evaluate DC signal dependency.

You can easily observe your devices behavior under various DC bias conditions without using an external DC bias source.

The Option 001 also provides a feature that allows you to monitor both voltage and current values of the DC bias actually applied to the DUT. The monitored voltage (Vdc) and current (Idc) traces can be displayed.

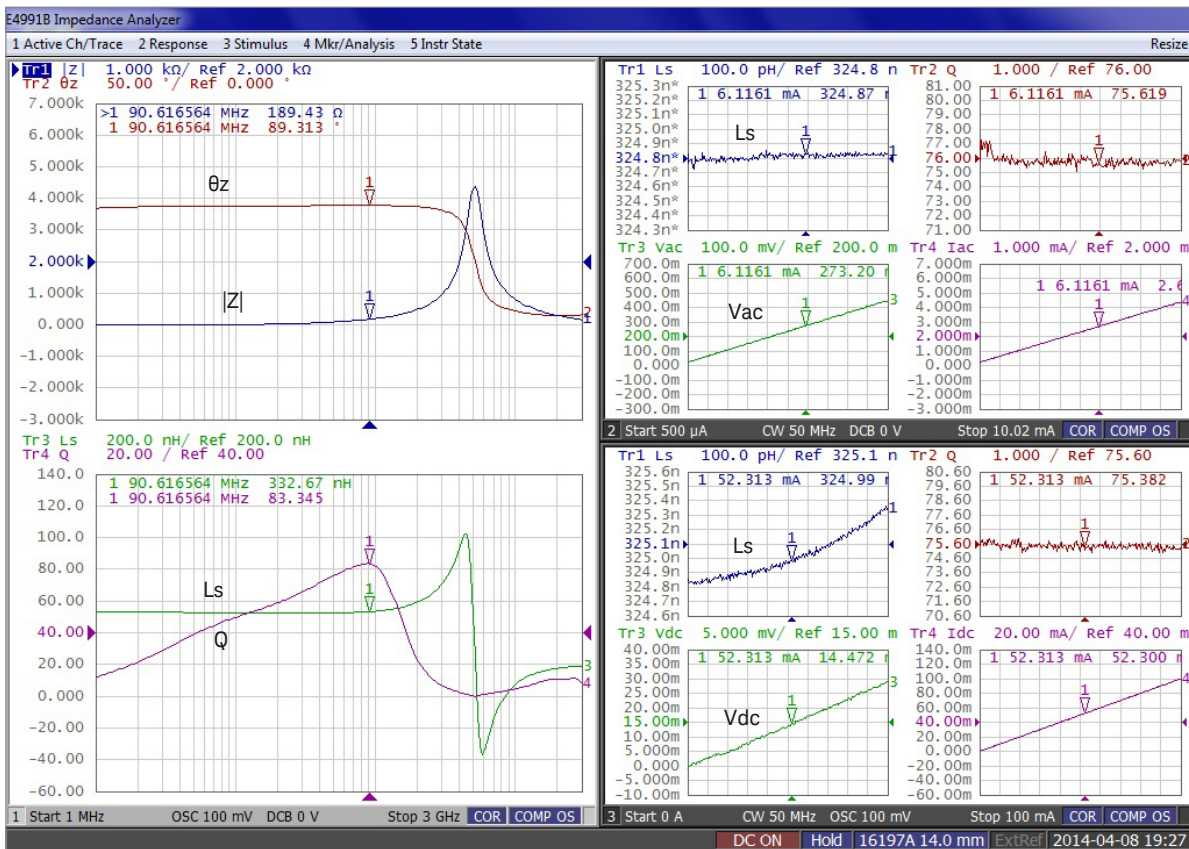

Left: Frequency dependency (330 nH inductor, frequency swept from 1 MHz to 3 GHz, OSC level = 100 mV)  
Upper right: Test signal level dependency (330 nH inductor, signal-level swept from 500  $\mu$ A to 10 mA, frequency = 50 MHz)  
Lower right: DC level dependency (330 nH inductor, DC-level swept from 0 A to 100 mA, frequency = 50 MHz, OSC level = 100 mV)

## Segment Sweep for Efficient Analysis

The segment sweep function allows you to divide the sweep range into segments. Each segment, including the frequency range, number of points, averaging factor, test signal level, and DC bias can be set independently. This can be achieved with a single sweep. The segment sweep setting can also be exported to a CSV file.

Evaluation of a crystal resonator requires that the nominal resonant/anti-resonant frequencies and some spurious frequencies be determined. You can perform a sweep measurement for a specific range, eliminating the ranges that aren't needed.

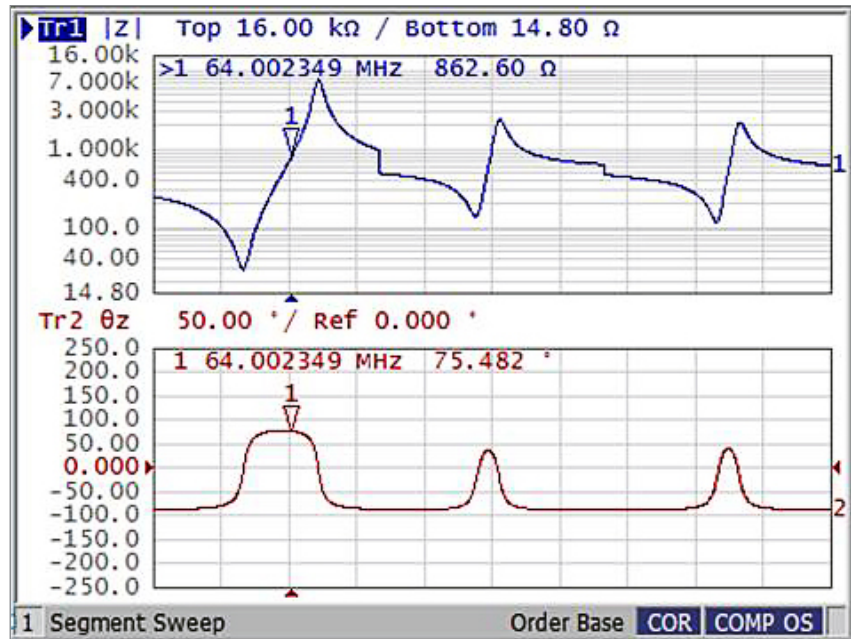

Crystal resonator evaluation by segment sweep (64 MHz crystal, OSC level = 500 mV)

## Equivalent Circuit Analysis

The purpose of equivalent circuit analysis is to model the impedance versus frequency characteristics with three or four elements.

Seven different multi-parameter models accommodate different types of devices such as capacitors, inductors or resonators. You can simulate the impedance trace of your own equivalent circuit parameter values and then compare it with an actual measurement trace. The equivalent circuit parameters can also be saved as a text file.

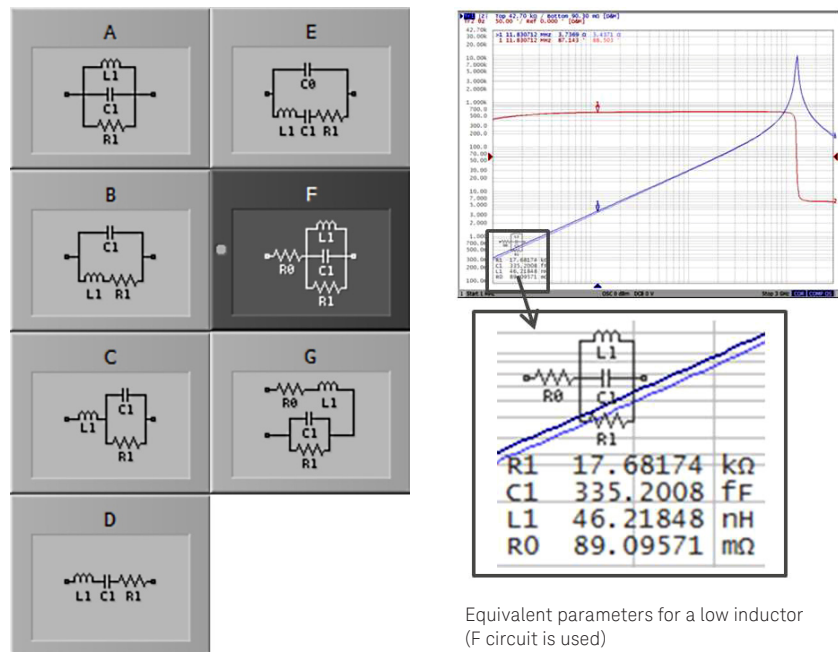

Seven selectable equivalent circuit models

Equivalent parameters for a low inductor (F circuit is used)

## Unparalleled Accuracy

The E4991B offers the highest level of impedance measurement accuracy and repeatability over a wide impedance/frequency range up to 3 GHz.

- 0.65% basic impedance measurement accuracy
- 120 m $\Omega$  to 52 k $\Omega$  impedance measurement range (10% measurement accuracy range)
- Small trace noise

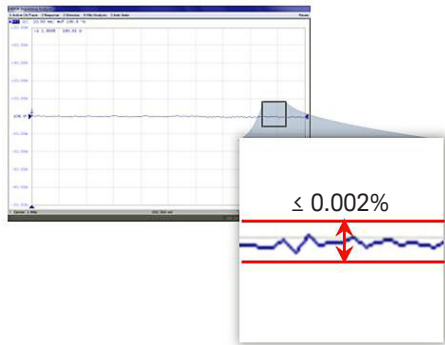

$\leq 0.002\%$  trace noise for accurate and repeatable measurements ( $\leq 0.001 \Omega$ , 50  $\Omega$  at 100 MHz, Point ave. = 8, 1 sigma with 200 times measurement)

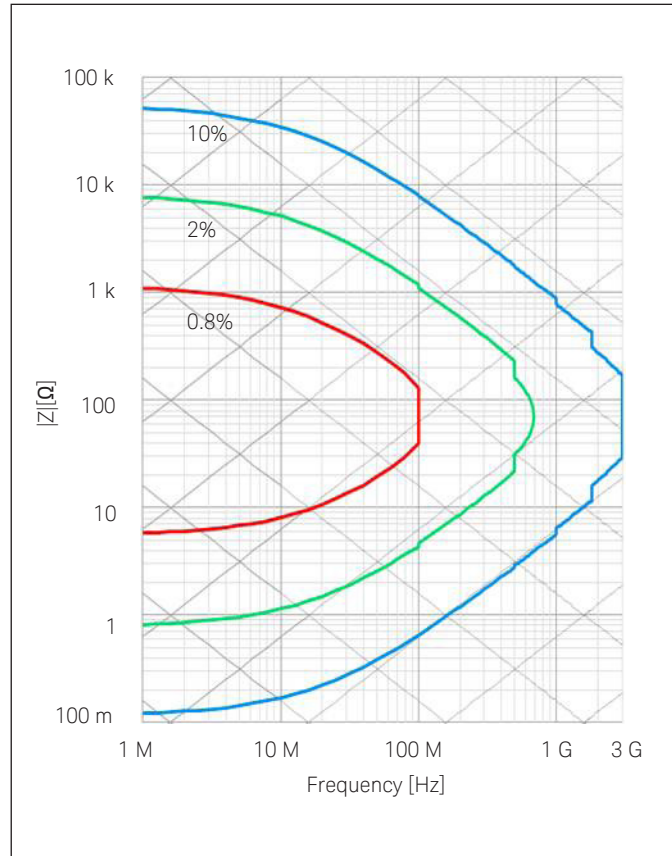

10% impedance measurement accuracy range of E4991B (OSC level = -3 dBm or -13 dBm, Point ave.  $\geq 8$ )

## Choose Your Application

Take advantage of available options to extend the value of your test equipment. The three options below offer measurement accuracy and reliable measurement results.

For complete measurement accuracy specifications refer to the data sheet.

- Option 002 material measurement firmware
- Option 007 temperature characteristics test kit
- Option 010 probe station connection kit

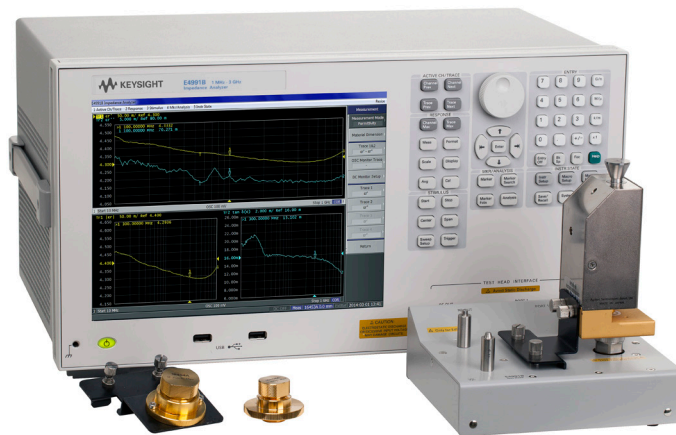

E4991B with material fixtures



## Direct Readout of Material Parameters

The E4991B with Option 002 material measurement firmware can provide direct readout of material parameters such as complex permittivity and complex permeability up to 1 GHz as well as impedance measurement parameters. Simple measurements are possible by using the dielectric material test fixture 16453A, and the magnetic material test fixture 16454A.

Measureable parameters:

Permittivity:  $|\epsilon_r|$ ,  $\epsilon_r'$ ,  $\epsilon_r''$ ,  $\tan\delta(\epsilon)$

Permeability:  $|\mu_r|$ ,  $\mu_r'$ ,  $\mu_r''$ ,  $\tan\delta(\mu)$

The 16453A is used for permittivity measurements. A sheet of solid substrate material, such as ceramic, polymer or PC board can be inserted between the electrodes.

## Accurate Temperature Characteristics Test Solution

The E4991B with Option 007 temperature characteristics test kit includes a test fixture stand that can be placed in a temperature chamber, a high temperature cable, and an extension cable. This solution provides highly accurate temperature characteristics analysis capabilities within a wide temperature range, from  $-55\text{ }^\circ\text{C}$  to  $+150\text{ }^\circ\text{C}$ .

This solution is suitable for components and material characteristic measurements under actual operating temperature or for stress tests.

A Microsoft Excel VBA sample program for temperature characteristics test has been pre-installed into the E4991B, and it can be copied to an external PC. The excel VBA sample program provides the temperature chamber control, measurement parameter setup, and temperature profile setup to allow for easy operation.

This sample program is compatible with a bench-top temperature chamber (provided by ESPEC), for a complete automated temperature characteristics test system. Also, the sample program can be modified for your specific temperature chambers.

The 16454A is used for permeability measurements. This single-wound, coil-structured test fixture holds toroidal-shaped magnetic materials, such as soft-ferrite and magnetic cores.

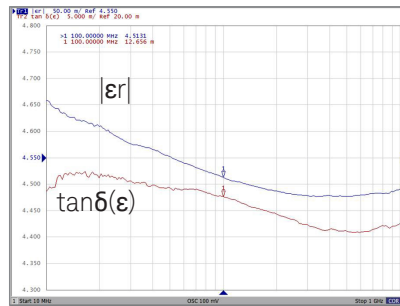

Frequency dependency of a dielectric material (glass epoxy,  $\epsilon_r = 4.5$ )

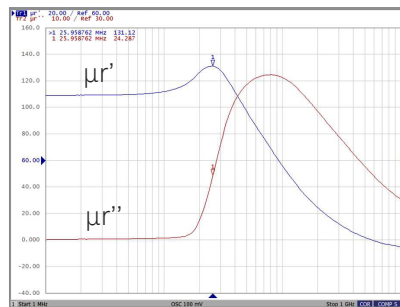

Frequency dependency of a magnetic material (ferrite,  $\mu_r = 120$ )

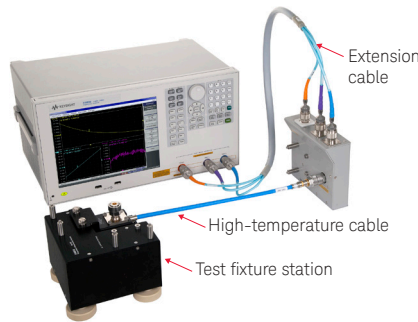

Contents of Option 007

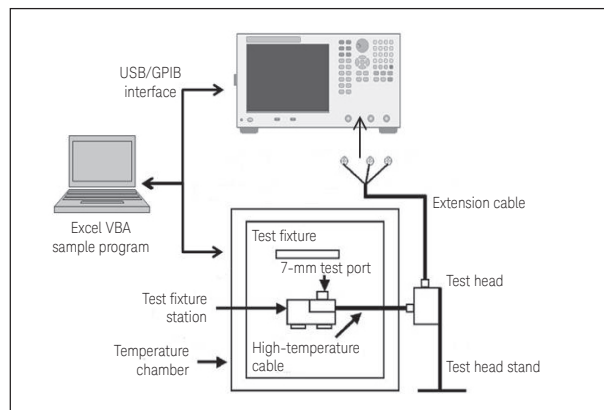

Configuration of automated temperature characteristics test system

## Materials Measurement Software (N1500A-005)

Dielectric and magnetic materials can be measured on E4991B up to 1 GHz with appropriate fixtures. The N1500A Option 005 provides versatile materials measurement using the 16453A (for magnetic materials) and 16454A (for dielectric materials) fixtures. The easy-to-use user interface for calibration, limit test, and report generation functions assure comprehensive and accurate materials measurements on E4991B. The N1500A software can run either on E4991B or an external PC.

## Accurate Impedance Measurement with Probe Station

The E4991B with Option 010 probe station connection kit offers an accurate on-wafer or micro-component impedance measurement solution up to 3 GHz.

Option 010 includes;

- Small E4991B test head with 7-mm connector
- Extension cable (1m)
- 7mm – 3.5mm (f) adapter x 1each
- N (m) – SMA (f) adapter x 3 each



Small test head, extension cable and N – SMA adapters

With this kit, you can easily establish a reliable measurement system in a short amount of time. A small test head is connected instead of the furnished test head.

The E4991B with Option 010 has a guaranteed impedance measurement specification at the end of the extended 7-mm test head port. This is an important element for accurate impedance measurements, since port extensions usually de-grades the measurement accuracy. The situation becomes even worse if the cable has an improper characteristic; the extension cables and test head solve this issue. The test head is small enough to be brought closer to the probe stations so that the measurement error caused by this extra length is minimized.

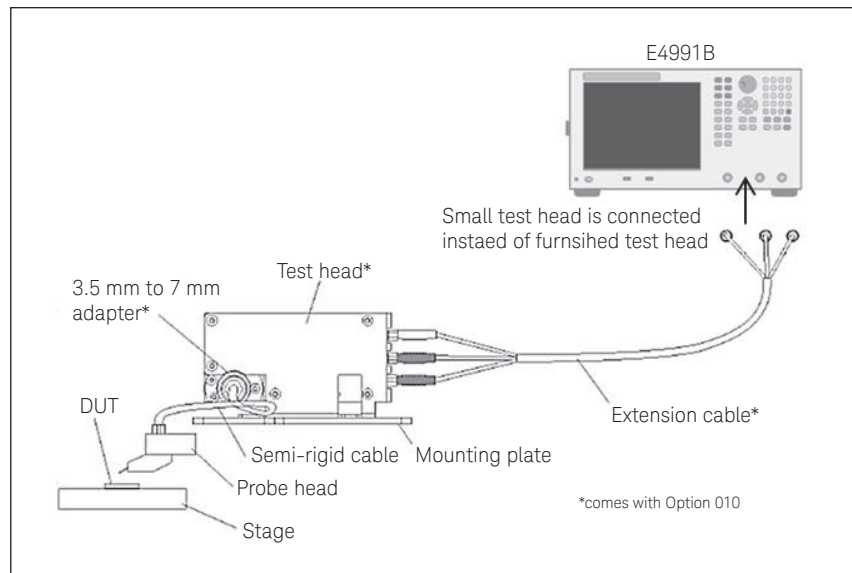

Probe measurement configuration using Option 010

In addition to the E4991B with Option 010, a probe station and probe heads must also be purchased separately. This option works with any probe station, but the Cascade Microtech probe station is recommended.

## Choose Your Test Fixture

### 16192A (DC to 2 GHz)

For side electrode SMD.  
1608 (mm)/0603 (inch) or larger size.

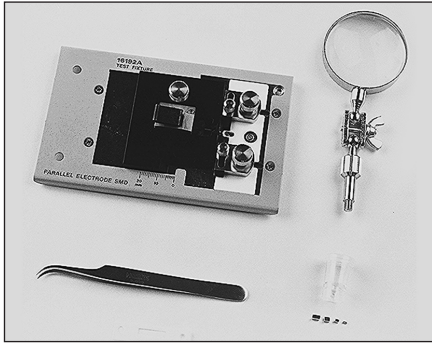

### 16194A (DC to 2 GHz)

For leaded or SMD within temperature range from -55 to +200 °C.

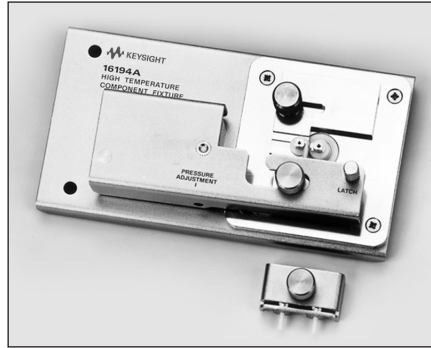

### 16453A (1 MHz to 1 GHz)

For permittivity measurement of dielectric materials for the following size:

Diameter  $\geq$  15 mm  
Thickness  $\leq$  3 mm



### 16196A/B/C/D (DC to 3 GHz)

Coaxial fixture specialized for the following SMD sizes:

16196A: 1608 (mm)/0603 (inch)  
16196B: 1005 (mm)/0402 (inch)  
16196C: 0603 (mm)/0201 (inch)  
16196D: 0402 (mm)/01005 (inch)



### 16197A (DC to 3 GHz)

For bottom electrode SMD.  
0603 (mm)/0201 (inch) to  
3225 (mm)/1210 (inch)

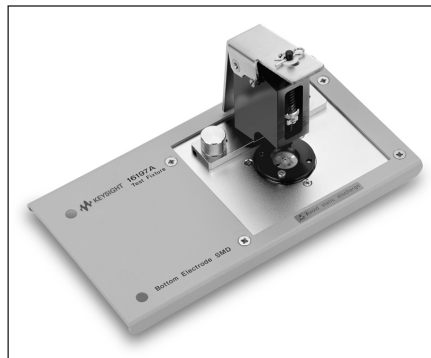

### 16454A (1 kHz to 1 GHz)

For permeability measurement of toroidal-shaped magnetic materials.

Small size:

Outer diameter  $\leq$  8 mm  
Inner diameter  $\geq$  3.1 mm  
Thickness  $\leq$  3 mm

Large size:

Outer diameter  $\leq$  20 mm  
Inner diameter  $\geq$  5 mm  
Thickness  $\leq$  8.5 mm



### 16200B (1 MHz to 1 GHz)

For measuring a DUT with DC bias up to 5 A. An external DC source is required.



### 16200B DC bias adapter connected to the E4991B

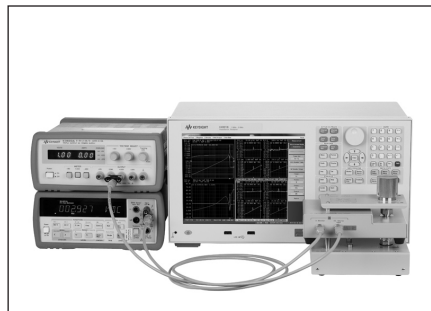

## Migrating from E4991A to E4991B

The E4991B includes all the functionality of the industry-standard E4991A impedance analyzer while exceeding the performance and providing more powerful functions, intuitive user interface and PC connectivity. Three frequency options (1 MHz to 500 MHz/1 GHz/3 GHz) and frequency upgrades allow you to choose the most appropriate frequency option with the least amount of investment.

### Key specifications and function comparison

	<b>E4991B</b>	<b>E4991A</b>
Frequency	1 MHz to 500 MHz/1 GHz/3 GHz, three frequency options are available	1 MHz to 3 GHz
Measurement parameters	Z,  Y , $\theta$ , R, X, G, B, L, C, D, Q,   $\Gamma$  , $\Gamma_x$ , $\Gamma_y$ , $\theta\Gamma$ , Vac, Iac, Vdc1, Idc1	Z,  Y , $\theta$ , R, X, G, B, L, C, D, Q,   $\Gamma$  , $\Gamma_x$ , $\Gamma_y$ , $\theta\Gamma$
Material parameters	$\epsilon_r$  , $\epsilon_r'$ , $\epsilon_r''$ , $\tan\delta(\epsilon)$ ,   $\mu_r$  , $\mu_r'$ , $\mu_r''$ , $\tan\delta(\mu)$	$\epsilon_r$  , $\epsilon_r'$ , $\epsilon_r''$ , $\tan\delta(\epsilon)$ ,   $\mu_r$  , $\mu_r'$ , $\mu_r''$ , $\tan\delta(\mu)$
Basic accuracy	$\pm 0.65\%$	$\pm 0.8\%$
Z measurement range	120 m $\Omega$ to 52 k $\Omega$ at 1 MHz ( $\pm 10\%$ measurement accuracy)	130 m $\Omega$ to 20 k $\Omega$ at 1 MHz ( $\pm 10\%$ measurement accuracy)
OSC level	4.47 mVrms to 502 mVrms/89.4 $\mu$ Arms to 10 mArms/-40 dBm to +1 dBm	4.47 mVrms to 502 mVrms/89.4 $\mu$ Arms to 10 mArms/-40 dBm to +1 dBm
DC bias	0 to $\pm 40$ V/100 mA, 1 mV/2 $\mu$ A resolution (Option 001)	0 to $\pm 40$ V/50 mA, 1 mV/10 $\mu$ A resolution (Option 001)
Measurement time	2.2 ms/point	10 ms/point
Number of points	2 to 1601	2 to 801
Trace noise example (50 $\Omega$ at 100 MHz, 1 sigma with 200 times measurement)	< 0.0018 $\Omega$ (0.0036%) at point average = 1	< 0.0035 $\Omega$ (0.007%) at point average = 1
Calibration	Open/short/50 $\Omega$ /low-loss-capacitor	Open/short/50 $\Omega$ /low-loss-capacitor
Compensation	Open/short, electrical length, port extension	Open/short, electrical length, port extension
Channels/traces	4-channel/4-trace	1-channel/3-trace
Data storage	SSD (built-in), external devices connected via USB ports	HDD (built-in), 1.44 MB FDD
Interface	USB (front 2, rear 4), GPIB, LAN, 24 Bit I/O, USBTMC	USB (rear 2), GPIB, LAN
Control commands	E4991B unique SCPI	E4991A unique SCPI
Size (mm), weight	425 (W) x 235 (H) x 296 (D), 13 kg	425 (W) x 235 (H) x 445 (D), 17 kg

1. Option 001 is required

## Ordering Information

### E4991B Impedance analyzer

- Test head
- 7 mm calibration kit with torque wrench
- Power cord
- Installation guide
- CD-ROM IO libraries

Model-Option	Description
E4991B-050	1 MHz to 500 MHz
E4991B-100	1 MHz to 1 GHz
E4991B-300	1 MHz to 3 GHz
E4991B-001	DC bias
E4991B-002	Material measurement firmware
E4991B-007	Temperature characteristic test kit
E4991B-010	Probe station connection kit

### Other Options

E4991B-1E5	High stability
E4991B-810	Add keyboard
E4991B-820	Add mouse
E4991B-1CM	Rack mount kit
E4991B-1CN	Front handle kit
E4991B-1CP	Rack mount and front handle kit
E4991B-1A7	ISO 17025 compliant calibration
E4991B-A6J	ANSI Z540 compliant calibration

Model-Option	Description
<b>E4991BU upgrade kits</b>	
E4991BU-100	Upgrade from 500 MHz to 1 GHz
E4991BU-300	Upgrade from 1 GHz to 3 GHz
E4991BU-301	Upgrade from 500 MHz to 3 GHz
E4991BU-001	Add DC bias
E4991BU-002	Add material measurement firmware
E4991BU-007	Add temperature characteristic test kit
E4991BU-010	Add probe station connection kit
E4991BU-1E5	Add high stability timebase
E4991BU-040	Upgrade OS, from Windows 7 to Windows 10, for E4991B

Model-Option	Description
<b>Material Measurement Software</b>	
N1500A-005	Parallel Plate/Inductance Method Up to 1 GHz <sup>1</sup>

1. Transportable with dongle key. Operation frequency is up to the maximum frequency of E4991B frequency option. Can run either on E4991B or on an external PC.



ООО «4ТЕСТ»

Телефон: +7 (499) 685-4444

info@4test.ru

www.4test.ru